

Intelligent Temperature Controller User Manual

Applicable for AI208X-A version



Features

- Optional input signal types.
- PID arithmetic and with auto-tuning function.
- Different control types (please refer OT parameters).
- RUN/STOP function can be switch.
- Heating and cooling dual output suitable for extruder control.

National High-tech Enterprise/ National Standard Drafting Unit
 Hotline: 400-0760-168 Version code:KKAI208X-A01E-A/4-20230919

The instruction explain instrument settings, connections,name and etc, please read carefully before you use the temperature controller. Please keep it properly for necessary reference.

I. Model Illustration

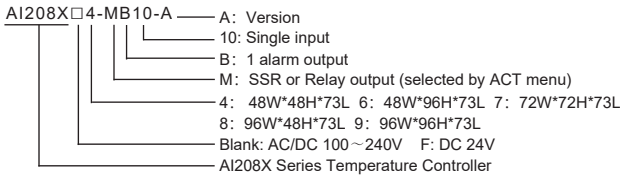

II. Order Information

NO	Model	Control output	Alarm
1	AI208X-4/6/7/8/9-MB10	RELAY/SSR	1

III. Specifications

1. Electrical parameters:

Sample rate	2 times per second
Relay capacity	AC 250V /3A Life of rated load>100,000 times
Power supply	AC/DC 100 ~ 240V (85-265V) , DC 24V
Power consumption	< 10VA
Environment	Indoor use only, temperature: 0~50°C no condensation, humidity < 85%RH, altitude<2000m
Storage environment	-10 ~ 60°C, no condensation
SSR output	DC 24V pulse voltage, load<30mA
Insulation impedance	Input, output, power VS meter cover > 20MΩ
ESD	IEC/EN61000-4-2 Contact ±4KV /Air ±8KV perf.Criteria B
Pulse triap anti-interference	IEC/EN61000-4-4 ±2KV perf.Criteria B
Surge immunity	IEC/EN61000-4-5 ±2KV perf.Criteria B
Voltage drop & short interruption immunity	IEC/EN61000-4-29 0% ~ 70% perf.Criteria B
Isolation voltage	Signal input, output, power: 1500VAC 1min, <60V low voltage circuit: DC500V, 1min
Total weight	About 400g
Cover material	The shell and panel frame PC/ABS (Flame Class UL94V-0)
Panel material	PET(F150/F200)
Power failure memory	10 years, times of writing: 1 million times
Panel Protection level	IP65(IEC60529)
Safety Standard	IEC61010-1 Overvoltage category II , pollution level 2, levelII (Enhanced insulation)

2. Measured signal specifications:

Input type	Symbol	Measure range	Resolution	Accuracy	Input impedance /auxiliary current
K	K	-50 ~ 999	1°C	0.5%F.S.±3digits	> 500kΩ
J	J	0 ~ 999	1°C	0.5%F.S.±3digits	> 500kΩ
E	E	0 ~ 850	1°C	0.5%F.S.±3digits	> 500kΩ
T	T	-50 ~ 400	1°C	0.5%F.S.±2°C	> 500kΩ
PT100	PT	-200 ~ 600	1°C	0.5%F.S.±3digits	0.2mA
CU50	CU	-50 ~ 150	1°C	0.5%F.S.±3°C	0.2mA
CU100	CU	-50 ~ 150	1°C	0.5%F.S.±1°C	0.2mA

IV.Panel Illustration

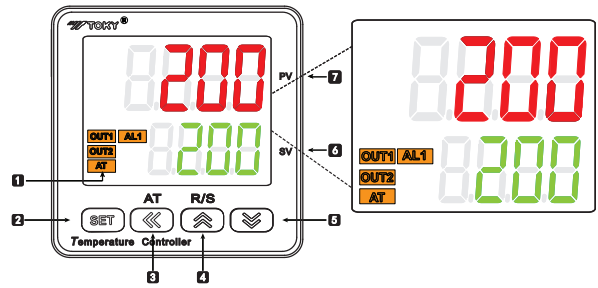

No.	Symbol	Name	Function
1	OUT1	OUT1 (Orange)	Main control output indicator, lights on when output ON.
	OUT2	OUT2 (Orange)	Cooling output indicator, lights on when output ON.
	AL1	Alarm 1# (Orange)	1st alarm output indicator, lights on when alarm output, lights off when no alarm output.
	AT	AT indicator(Orange)	Auto tune indicator, lights on when it is under auto tune status.
2	SET	SET key	Menu key/confirm key, to enter or exit the modification mode, or to confirm and save the modified parameter.
3	◀	SHIFT/AT key	Activate key/ shift key/ AT auto tune key (in measure and control mode, long press to enter/exit auto tune)
4	▲	UP key/ R/S	Add key, in measure and control mode, long press it to shift RUN/STOP mode, or check the menu in reverse order.
5	▼	DOWN key	Reduce key, check the menu in sequence
6	SV	Display (green)	Set value / parameter display window, the control is stopped when it displays "STOP"
7	PV	Display (red)	Measured value/ parameter code display window

V. Dimension and installation size

1. Dimension and cutout size

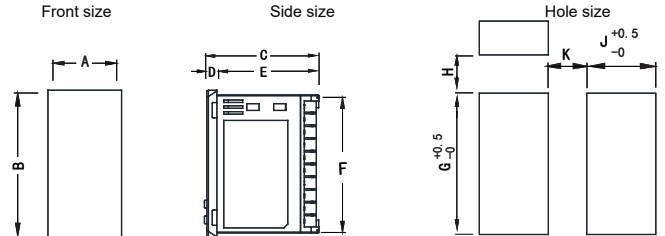

Model	A	B	C	D	E	F	G	H(Min)	J	K(Min)
4:(48*48)	48	48	73	6.5	66.5	44	45	25	45	25
6:(48*96)	48	96	73	6.5	66.5	90	91.5	25	45	25
7:(72*72)	72	72	73	6.5	66.5	66	67.5	25	67.5	25
8:(96*48)	96	48	73	6.5	66.5	44	45	25	91.5	25
9:(96*96)	96	96	73	6.5	66.5	90	91.5	25	91.5	25

2. Installation

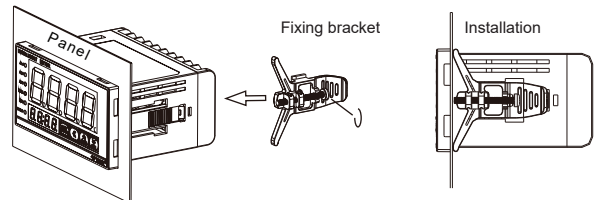

Installation method:Put the instrument into the cutout hole,and then place the fixing bracket on the installation slot of the instrument housing,push the brackte towards the panel until the instrument is fixed(the operation is as shown in the above)

VI. Connections

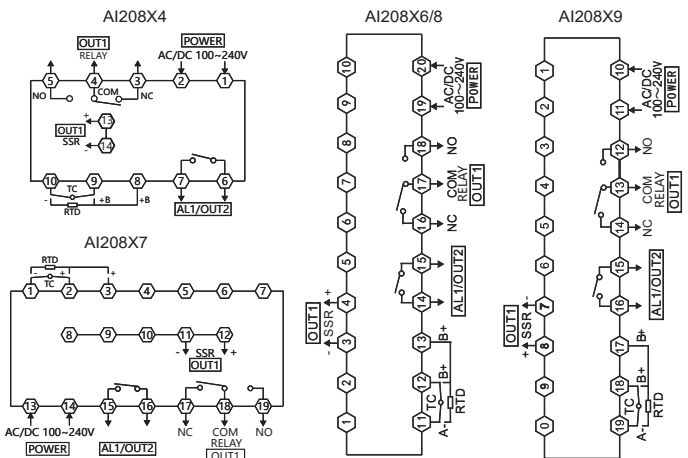

VIII. Operation process and menu illustration

1. Operation process & method

1). Modify SV Value

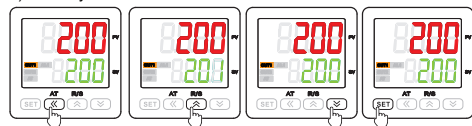

Press "◀" SV value flash Press "▲" Increase SV value Press "▼" Reduce SV value Press "SET" Save SV value

2). Common Menu

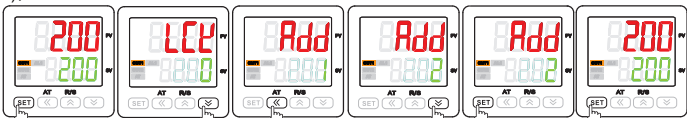

Press "SET" > 3 sec, enter Common Menu
 Press "*" or "▲", move among menus
 Press "▲", parameter value flash
 Press "*" or "▼", modify parameter value
 Press "SET", save modified value
 Press "SET" > 3 sec, exit Common Menu

3). Advanced menu



Press "SET" > 3 sec, enter Common Menu
 Press "SET" to find LCK menu
 SET LCK=33
 Press "SET" to enter Advanced Menu
 Press "▲", parameter value flash



Press "*" or "▼", modify parameter value
 Press "SET", save modified value
 Press "SET" > 3 sec, exit Advanced Menu

IX. Menu Illustration

NOTE: The meter will hide unrelated parameters according to OT parameter setting. We suggest to set the OT parameter before using the meter for the first time.

□: No matter what model, what control mode it is, it will always display these parameters.
 ▨: According to different model, control mode, these parameters will be hidden.

1. Regular Menu

No.	Symbol	Name	Illustration	Setting range	Factory setting
1	AL1	AL1	1st alarm value. Note: the minus is dealt as absolute value when it is as deviation alarm.	FL~FH	10
2	HY1	HY1	1st alarm hysteresis	0~100	1
3	AD1	AD1	1st alarm mode. Note: when AL1 is used as OUT2 (cooling output), should set the value AD1=0 (close alarm function). When AD1>6, 2nd alarm function is invalid.	0~12	3
4	PS	PS	Display correction value, display value= actual measured value + display correction value	-199~999	0
5	INP	INP	Optional input measured signal type: refer to input signal parameters table. Note: after the setting, need to modify other relevant parameters too.	K~CU100	K
6	OT	OT	Control mode. 0: ON/OFF heating control, relevant parameter: DB. 1: PID heating control, relevant parameters: P, I, D, OVS, CP, ST, SPD. 2: Compressor cooling control, relevant parameter: DB, PT. 3: PID heating & cooling control (cooling control OUT2 will output through AL1 relay), relevant parameters: P, I, D, OVS, DB, CP, CP1, PC, ST, SPD. 4: Over temperature cooling output, relevant parameter: DB	0~4	1
7	P	P	Proportional band. The smaller the value is, the faster the system responds, otherwise, it is slower. Increasing proportional band can reduce the oscillation, but it will increase the control deviation. Reducing proportional band can reduce control deviation, but it will cause oscillation	0~999	30
8	I	I	Integral time. The smaller the value, the stronger the integral action, the better performance on eliminating the deviation between PV and SV. If the integral action is too weak, the deviation might not be eliminated. Unit: sec.	0~999	120
9	D	D	Differential time. Reducing it to a suitable value can prevent the oscillation of the system. The greater the value, the stronger the differential action. Unit: sec	0~999	30
10	OVS	OVS	Overshoot limit. During PID control process, when PV(measured value) > SV(set value) + OVS (overshoot limit), force to close output. The smaller this value is, the smaller the PID adjustment range is, the worse the control stability is. Please set the appropriate value according to the actual situation.	0~999	5
11	DB	DB	ON/OFF control hysteresis(positive and negative numbers work the same); when OT=3, it is the dead zone for cooling control(positive and negative numbers work differently); after change the INP setting, please change this parameter according to the decimal point position.	0~100	5
12	CP	CP	OUT1 control cycle. 1: SSR control output, 4~200: relay control output. Unit: s	1~200	20
13	CP1	CP1	OUT2 relay output cycle. Unit: sec	4~200	20
14	PC	PC	OUT2 cooling proportionality coefficient. The higher of value, the stronger of cooling effect.	1~100	10
15	LCK	LCK	Lock function. 001:SV value can't be modified. 010: menu set value can be checked only, can't be modified. 033: enter the advanced menu. 123: menus reset to factory setting.	0~999	0

2. Advanced menu illustration

No.	Symbol	Name	Illustration	Setting range	Factory setting
16	ACT	ACT	Control execution type. 0: relay output, 1: SSR output	0~1	0
17	ST	ST	Auto-tune activation after power-on. 0: work normally after power-on, 1: automatically enter PID parameters auto-tune status after power-on; press and hold <<AT key to exit auto-tune.	0~1	0
18	SPD	SPD	PID control speed adjustment. Option: 0(N) no function, 1(s) slow, 2(ss) medium slow, 3(SSS) very slow, 4(F) fast, 5(FF) medium fast, 6(FFF) very fast	0~6	N
19	PT	PT	Compressor start delay time, unit: s	0~999	180
20	AE1	AE1	1st alarm extensions function, refer to alarm extension function table	0~5	0

No.	Symbol	Name	Illustration	Setting range	Factory setting
21	FL	FL	Measure range low limit, the set value must be less than measure range high limit	Refer to measured signal parameter table	-50
22	FH	FH	Measure range high limit. The set value must be more than measure range low limit.		999
23	DP	DP	Decimal point setting, effective below 100.	0 ~ 1	0
24	FT	FT	Filter coefficient. The higher the value, the stronger the filter function.	0~255	10
25	UT	UT	Temperature unit conversion, Celsius, Fahrenheit	°C, °F	°C
26	DTR	DTR	PV fuzzy tracking value, properly set this value on some occasions, it can get a more stable control display value, this value is unrelated with actual measured value. Note: after setting this value, when alarm setting value is equal to SV set value, alarm output operation is subject to actual measured value. Set as 0 to close this function.	0.0~2.0	1.0
27	SSM	SSM	Enable R/S key to switch RUN / STOP operation. 0: Forbidden 1: Enable This setting is only for panel operation, not for communication operation.	0 ~ 1	0
28	VER	VER	Software version, read only		

IX. Alarm function and output logic diagram:

(1) Alarm parameters and output logic diagram:

Symbol description: "▲" means HY, "▲" means alarm value, "▲" means SV value

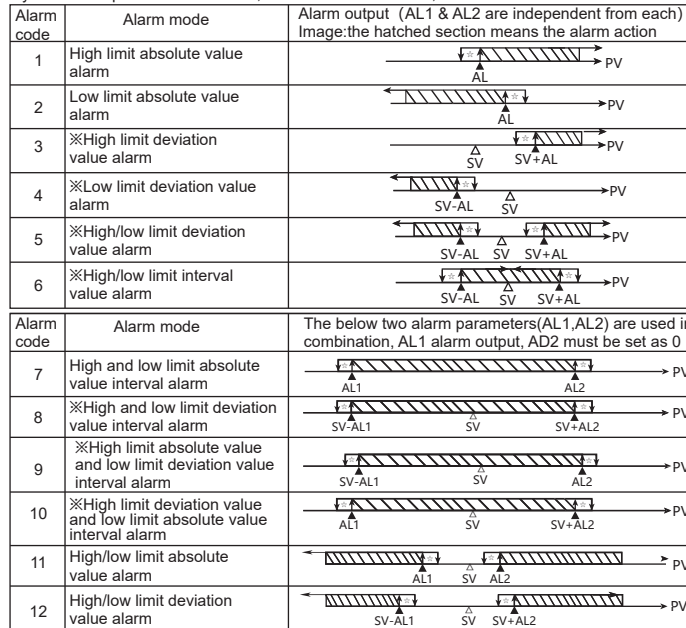

※When the alarm value with deviation alarm is set as a negative number, it will be dealt as an absolute value.

(2) Alarm extension function table

AE1/AE2 value	Alarm handling method when it displays HHHH/LLLL	Power on, alarm inhibition
0	Alarm status remains the same	Power on, no alarm inhibition (As long as the alarm condition is met, alarm output immediately.)
1	Forced alarm output	Power on, alarm inhibition (After power on and before the PV value reaches the SV for the first time, the alarm will not output. After that alarm work normally)
2	Forced alarm close	
3	Alarm status remains the same	
4	Forced alarm output	
5	Forced alarm close	

X. Key function operation

- RUN/Stop mode
 - Under the measure mode, press and hold "R/S" key > 3 sec to enter STOP mode, SV window will display "STOP". Under STOP mode, press and hold "R/S" key to exit STOP mode.
 - Under STOP mode, support to modify SV value and switch operation.
 - Under STOP mode, main control output will stop.
- PID auto-tune operation:
 - Usually, the default PID parameters of this product are not suitable for all occasions; please use auto-tuning function to get a suitable PID parameter.
 - The meter will enter control output since the power input, please set the meter as STOP mode to not affect the auto-tuning result, or switch off the power of control output load. No matter how to operate, should ensure that the set value is greater than the current measured value; the greater the drop, the better.
 - Before auto-tuning, please set the proper alarm value, or remove the alarm condition to avoid the effect of alarm output.
 - Set SV value.
 - Set parameter OT as 1 (PID control).
 - Under the condition of PV value at normal room temperature, please exit STOP mode or input the load power, and keep pressing "AT" key to enter auto-tuning mode, then AT indicator turns on.
 - Auto-tuning need a period, to ensure the auto-tuning result, please don't modify parameters or power-off during auto tuning.
 - When AT light is off, it will exit the auto-tuning mode. PID will update automatically, and the meter will control automatically and precisely.
 - During auto-tuning procedure, press "AT" key, measure beyond the range, display abnormally, shift to "STOP" mode, power-off will stop the auto-tuning.
 - Experienced user can set the proper PID parameter with their rich experience.

- PID heating & Cooling control operation (suitable for injection molding machine and extruder)
 - Set the control mode OT to 3. (heating and cooling control)
 - PID heating control act on OUT1; Cooling control act on OUT2.
 - Cooling control OUT2 will make output by AL1 alarm relay.
 - Please set the cooling start offset to a value larger than 5, to ensure the cooling would not affect PID heating control.
 - Please set the cooling control cycle CP1 to a proper value, and change the cooling scaling factor to a proper value.
 - When PV value > SV+DB value, the cooling control start to effect; the bigger value of PV, the longer output time of OUT2

XI. Checking methods of simple fault

Display	Checking methods
LLLL/HHHH	Check whether: the sensor is in poor contact or wrong wiring, FH/FL value is normal, the environment temperature out of range, the input signal is selected correctly. (INP menu)

XII. Version and Revision Record

Date	Version	Revision Record
2023.09.19	A/4	Adding fixed bracket diagram