

Sensor Meter User Manual



Features:

- The red LED display value of real time,maximum & minimum on the upper row,and the green LED display measure unit or alarm value.
- The maximum 3 loop alarm output
- Many kinds of linear signal inputs or temperature sensor signals
- Analog analog,enabling conversion and calibration functions of measure range
- RS485 communication and Modbus-RTU protocol
- Power supply 100 ~ 240V AC/DC,
- Isolate DC24V feed output (30mA),
- Peak Hold function,to facilitate record maximum, minimum measurement data
- easy to operate, economical and practical.

KKSE04-A/1-20231024

2.Cable caution:

- 1)Please use specified compensation wire in the place of TC input;Please use insulated TC if the measured device is heated metal.
- 2)Please use the cable of lesser resistance in the place of RTD input,and the cable(3 wire) must be no resistance difference,but the total length is within 5m.
- 3)In order to avoid the effect of noise,please put the input signal away from meter cable,power cable,load cable to wiring.
- 4)In order to reduce the power cables and the load power cables on the effect of this product,please use noise filter in the place where easy to effect.You must install it on the grounding of the disk if you use the noise filter,and make the wiring to be shortest between noise filter output side and power connectors.Don't install fuse and switch on the wiring of noise filter output side,otherwise it will reduce the effect of noise filter.
- 5)It takes 5s from input power to output.If there is a place with interlocking actions circuit signal,please use timer relay.
- 6)Please use twisted pair with a shield for analog output line,to ensure the reliability of signal.
- 7)Please use twisted pair with a shield for remote RS485 communication cable,and deal with the shield on the host side earth,otherwise it will reduce the effect of noise filter.
- 8)This product is not the fuse;please set according to rated voltage 250V,rated current 1A if you need;fuse type:relay fuse.
- 9)Please use the suitable screw force and crimp terminal.
The screw terminal size: M3X8 (with 6.8X6.8 square base)
Recommended tightening torque: 0.4N.m
Proper cables: 0.25 ~ 1.65mm single cable/multiple core cable
- 10)Please don't put the Crimp terminal or bare wire part contact with adjacent connector.

II .Model Illustration

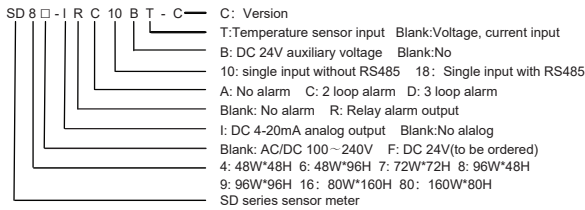

III .Order Information

Model	Signal input	Alarm	Auxiliary voltage	Analog output	Analog output
SD□-A10	4~20mA/0~10V				
SD□-A10B	4~20mA/0~10V		•		
SD□-RC10B	4~20mA/0~10V	2	•		
SD□-RC18B	4~20mA/0~10V	2	•		•
SD□-IRC10B	4~20mA/0~10V	2	•	•	
SD□-IRC18B	4~20mA/0~10V	2	•	•	•
SD□-A10-T	TC/RTD/mV/RT				
SD□-RC10B-T	TC/RTD/mV/RT	2	•		

IV .Specification

1.Electrical parameters

Sample rate	4SPS
Relay capacity	AC 250V /3A life of rate load>100 thousand times
Power supply	AC/DC 100 ~ 240V (85-265V)
Power consumption	<6VA
Environment	Indoor temperature:0 ~ 50°C no condensation; Humidity: < 85%RH; Altitude<2000m
Storage environment	-10 ~ 60°C, no condensation

The instruction explain instrument settings, connections,name and etc.please read carefully before you use the temperature controller.

I. Safety Caution

⚠ Warning

- 1) If the fault of the product or abnormal system lead to a serious accident, please set the appropriate circuit protection outside.
- 2) Before the connection completely, please do not power. Otherwise it may result in electric shock, fire, malfunction.
- 3) Do not use the product out of scope of specifications range. Otherwise, it may result in fire, malfunction.
- 4) Do not use in places with flammable and explosive gas.
- 5) Do not touch the site of high voltage power terminal site after power. Otherwise, there is danger of electric shock.
- 6) Do not disassemble, repair and modify this product. Otherwise, it may result in electric shock, fire, malfunction.

⚠ Caution

- 1) This product should not be used in a nuclear plant and medical equipment which associated with human life.
- 2) Some time,it will happen radio interference when the product uses in home environment.It should take adequate countermeasures.
- 3) This product has electric shock protection through improved insulation.And when using the product and connecting,it subject to compliance with specifications.
- 4) In order to avoid lightning surge,it should set appropriate surge suppression circuits when the product uses in the environment where the total cable length more than 30 metre.
- 5) The product uses in disk,and avoid to touch the part of high voltage,please take the necessary measure on the final product.
- 6) Please observe the precautions in this manual, otherwise there is risk of causing significant harm or accident.
- 7) Please observe the regulation when wiring.
- 8) To prevent to damage the machine and prevent to machine failure, the product is connected with power lines or large capacity input and output lines and other methods please install proper capacity fuse or other methods of protection circuit.
- 9) Please don't put metal and wire clastic mixed with this product,otherwise it may lead to electric shock, fire, fault.
- 10) Please tighten screw torque according to the rules.If not,it may lead to electric shock and fire.
- 11) In order not to interfere with this products to dissipate heat, please don't plug casing around the cooling vent hole and equipment.
- 12) Please don't knock or rub the panel with rigid thing.
- 13) The readers of this manual should have basic knowledge of electrical,control, computer and communications.
- 14) The illustration, example of data and screen in this manual is convenient to understand,instead of guaranteeing the result of the operation.
- 15) In order to use this product with safety for long-term,regular maintenance is necessary. The life of some parts of the equipments are by some restrictions, but the performance of some will change for using many years.
- 16) Without prior notice, the contents of this manual will be change. We hope these is no any loopholes, if you have questions or objections, please contact us.

⚠ Caution of Install & Connection

1.Installation:

- 1) This product is used in the following environmental standards.
(IEC61010-1) [Overvoltage category II, class of pollution 2]
- 2) This product is used in the following scope:surrounding environment, temperature, humidity and environmental conditions.
Temperature: 0 ~ 50°C; Humidity: 45 ~ 85%RH;Environment condition: Indoor warranty.The altitude is less than 2000m.
- 3) Please avoid using in the following places:
The place will be dew for changing temperature;with corrosive gases and flammable gas;with vibration and impact;with water, oil, chemicals, smoke and steam. facilities with Dust, salt, metal powder;and with clutter interference, static electric and magnetic fields, noise;where has air conditioning or heating of air blowing directly to the site.
- 4) On the occasion of the installation, please consider the following before installing several.
In order to protect heat saturated, please ensure adequate ventilation space.
Please consider connections and environment and ensure that the products below for more than 50mm space.
Please avoid to installed over the machine of the calorific value(Such as heaters, transformer, semiconductor operations, the bulk resistance).
When the surrounding is more than 50°C, please using the force fan or cooling fans.But don't let cold air blowing directly to the product.
In order to improve the anti - interference performance and security, please try to stay away from high pressure machines, power machines to install.
Don't install on the same plate with high pressure machine and the product.
The distance should be more than 200mm between the product and power line.

Current output	DC 4 ~ 20mA load < 500Ω, Temperature drift 250PPM
Communication port	RS485 port Modbus-RTU protocol, maximum input:30 units
Insulation impedance	Input,output,power cabinet > 20MΩ
ESD	IEC/EN61000-4-2 Contact ±4kV /Air ±8kV perf.Criteria B
Pulse trap anti-interference	IEC/EN61000-4-4 ±2kV perf.Criteria B
Lightning surge	IEC/EN61000-4-5 ±2kV perf.Criteria B
Frequency drop	IEC/EN61000-4-29 0% ~ 70% perf.Criteria B
Dielectric strength	Signal input & output & power 1500VAC 1min, below 60V Low voltage circuit between DC500V,1min
Total weight	About 400g
Material of case	The case and panel frame PC/ABS (Flame Class UL94V-0)
Material of mark	PET(F150/F200)
Power-off data protection	10 years, times of writing:1 million times
Protection level of panel	IP65(IEC60529)
Safety Standard	IEC61010-1 Overvoltage category II, pollution level 2, levelII (Enhanced insulation)

2.Signal parameters

Input	Symbol	Range	ratio	Accuracy	Input impedance/auxiliary current	Code
K	E	-50 ~ 1200°C	1°C	0.5%FS±3digits	>500KΩ	0
K.O	E.O	-50.0 ~ 500.0°C	0.1°C	0.5%FS±3digits	>500KΩ	1
J	J	0 ~ 1200°C	1°C	0.5%FS±3digits	>500KΩ	2
E	E	0 ~ 850°C	1°C	0.5%FS±3digits	>500KΩ	3
T	T	-50 ~ 400°C	1°C	0.5%FS±2°C	>500KΩ	4
N	n	-50 ~ 1200°C	1°C	0.5%FS±3digits	>500KΩ	5
B	b	600 ~ 1800°C	1°C	0.5%FS±2°C	>500KΩ	6
R	r	0 ~ 1600°C	1°C	0.5%FS±2°C	>500KΩ	7
S	S	-10 ~ 1600°C	1°C	0.5%FS±2°C	>500KΩ	8
PT100	PT	-200.0 ~ 600.0°C	0.1°C	0.5%FS±3digits	0.2mA	9
CU50	CU50	-50.0 ~ 150.0°C	0.1°C	0.5%FS±3°C	0.2mA	10
CU100	CU100	-50.0 ~ 150.0°C	0.1°C	0.5%FS±1°C	0.2mA	11
0 ~ 50mV	mV	-1999 ~ 9999	0.01%FS	0.5%FS±3digits	>500KΩ	12
0 ~ 400Ω	Ω	-1999 ~ 9999	0.01%FS	0.5%FS±3digits	0.2mA	13
0 ~ 10V	V	-1999 ~ 9999	0.01%FS	0.5%FS±3digits	>500KΩ	14
4 ~ 20mA	mA	-1999 ~ 9999	0.01%FS	0.5%FS±3digits	100Ω	15
0 ~ 5V	V	-1999 ~ 9999	0.02%FS	1%FS±3digits	>500KΩ	16
1 ~ 5V	V	-1999 ~ 9999	0.02%FS	1%FS±3digits	>500KΩ	17
0 ~ 20mA	mA	-1999 ~ 9999	0.01%FS	0.5%FS±3digits	100Ω	18

3. Isolation diagram

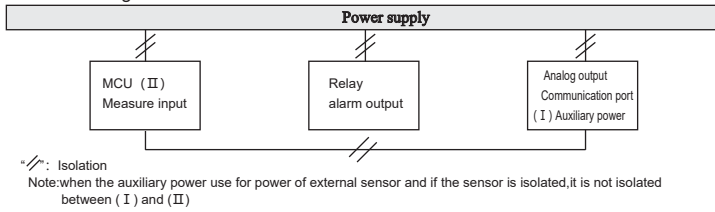

V. Name of universal panel

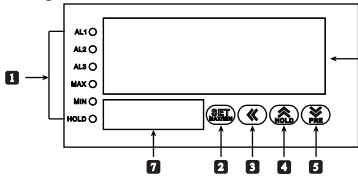

No.	Symbol	Name	Function
1	AL1	Alarm 1 indicator light	1st loop alarm output indication, alarm output with light, no alarm output without light
	AL2	Alarm 2 indicator light	2nd loop alarm output indication, alarm output with light, no alarm output without light
	AL3	Alarm 3 indicator light	3rd loop alarm output indication, alarm output with light, no alarm output without light
	MAX	Light of max value	when the MAX value indicator light, PV display the max value
	MIN	Light of min value	when the MIN value indicator light, PV display min value.
	HOLD	Light of hold value	when HOLD value indicator light, PV display hold value.
	2	SET	SET key
3	Shift	Shift key	Parameters modify and activate, left shift
4	Hold	Add/hold key	Increase the flashing value, hold measuring the instantaneous value
5	Reverse	Reduce/reverse key	Reduce the flashing value, reverse to browse menu.
6	PV	Upper display window	Display current/max/min value and parameter symbol, error indication
7	SV	Lower display window	Display measure unit, parameter and alarm value

VI. Unit symbol comparison

No.	Symbol	Unit	No.	Symbol	Unit	No.	Symbol	Unit
0	-	No	11	N	N	22	KV	KV
1	M	M	12	W	W	23	mA	mA
2	cm	cm	13	KW	KW	24	A	A
3	mm	mm	14	RPM	RPM	25	KA	KA
4	kg	kg	15	RPS	RPS	26	Ω	Ω
5	g	g	16	MPM	MPM	27	KΩ	KΩ
6	mg	mg	17	MPS	MPS	28	°C	°C
7	Mpa	Mpa	18	Hz	Hz	29	°F	°F
8	pa	pa	19	KHz	KHz	30	K	K
9	ba	ba	20	mV	mV			
10	mbar	mbar	21	V	V			

VII. Operation and Menu Direction

1. Operation of normal menu and shielding menu

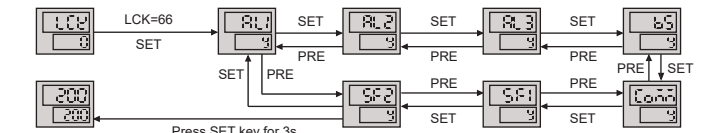
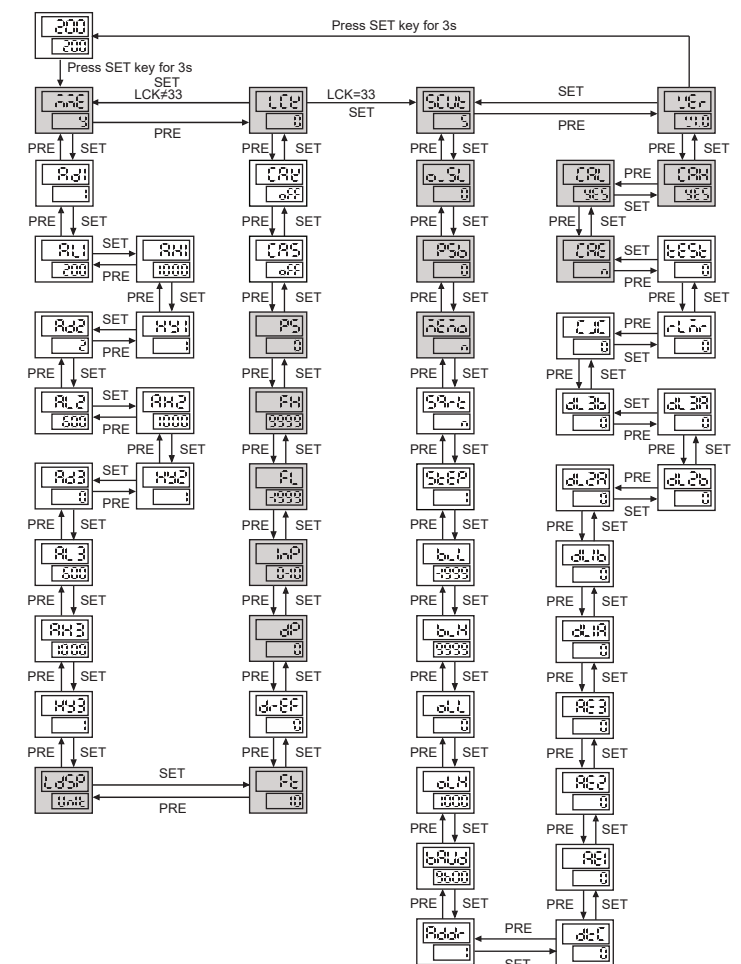

Menu shield function, the specification of function symbol as below:
AL1: AD1, AL1, HY1, AE1, DL1A, DL1B;
AL2: AD2, AL2, HY2, AE2, DL2A, DL2B;
AL3: AD3, AL3, HY3, AE3, DL3A, DL3B;
BS: BRL, BRH, OLL, OLH, TEST;
COMM: BAUD, ADDR, DTC;
SF1: CAS, CAK, SQRT;
SF2: DREF, STEP, CJC, RLMR;

When it display one of function symbol, bottom row will display "Y" or "N" (Y means start the function; N means stop the function)
 For example: if the meter have no first alarm circuit, please set the AL1 to "N" and then exit menu.
 But now, the menu and submenu will not display AL1, AD1, HY1, AE1, DL1A, DL1B and the alarm function stop to work.

- In the normal measurement mode and when the MME=Y, press "SET" key can switch the max/min/current value circularly.
- Enter MME, and when it displays "Y", press "Shift" key to restart recording max/min value.
- In the normal measurement mode, press "Hold" key can lock current value, and press again to unlock.
- Before CAS, CAK calibration functions are used, long press "SET" + "Reverse" (make sure PSB=0).

2. Directions of menu

No.	Menu name	Directions	Setting range	Factory default
1	MME	Max/min value record function activation. Y: start, N: close	0 (N) 1 (Y)	N
2	AD1	Optional 4 types alarm: 0: alarm close; L: low limit alarm; H: high limit alarm; Int: interval alarm; Out: outside the interval	0, L, H, Int, Out	L
3	AL1	1st alarm setting value	FL~FH	200
4	AH1	Scope of setting value for 1st alarm	FL~FH	1000
5	HY1	1st alarm backlash value	0~1000	1
6	AD2	Optional 4 types alarm, if it is 0, the alarm close	0, L, H, Int, Out	H
7	AL2	2nd alarm setting value	FL~FH	600
8	AH2	Scope of setting value for 2nd alarm	FL~FH	1000
9	HY2	2nd alarm backlash value	0~1000	1
10	AD3	Optional 4 types alarm, if it is 0, the alarm close	0, L, H, Int, Out	H
11	AL3	3rd alarm setting value	FL~FH	800
12	AH3	Scope of setting value for 3rd alarm	FL~FH	1000
13	HY3	3rd alarm backlash value	0~1000	1
14	LDSP	Choice of display on bottom row: no display, engineering unit, 1loop/2loop/3loop alarm value.	Non, Unit, AL1, AL2, AL3	Unit
15	FT	filter coefficient of digital filters. The higher of value, the greater the filter effect.	1~255	10
16	DREF	Display refresh cycles, unit: s	0~5	0
17	DP	Decimal location for linear signal	0~3	0
18	INP	Input signal types	Refer signal sheet page 3	0~10V/K
19	FL	Measured low limit, the setting value must less than measured high limit	Refer signal sheet page 3	0/-50

20	FH	Measured high limit, the setting value must more than measured low limit	Refer signal sheet page 3	1000/1200
21	PS	Display translation correction value	-1999~9999	0
22	CAS	Displayed value of low-input point, setting corresponding value of low-input point, press "Reverse" to decrease CAS until CAS=OFF, this function is disabled.	OFF, FL~FH	OFF
23	CAK	Displayed value of high-input point, setting corresponding value of high-input point, press "Reverse" to decrease CAK until CAK=OFF, this function is disabled.	OFF, FL~FH	OFF
24	LCK	Password, LCK=01, unit lock; LCK=10, menu lock; LCK=11, unit & menu lock; LCK=33, it can enter class 2 menu; LCK=5555, it will restore factory setting.	0~9999	0
25	SCUT	Small Signal Elimination, please refer description of o_SL for details	-1999~9999	5
26	o_SL	Display of choice o_SL=0, no function, o_SL=1, measured value<FL, display FL; measured value>FH, display FH. o_SL=2, measured value<SCUT/FL and display FL; measured value>FH, display FH. o_SL=3, measured value<SCUT, display the min value between FL & SCUT; measured value>FH, display FH.	0~3	0
27	PSb	Zero value, long press "Reverse" + "Hold" key to clear the display value, now zero value will save on PSb. If you preset the zero value, please long press "Reverse" + "Hold" key or modify PSb to zero. (The function is non-effective on temperature signal)	-1999~9999	0
28	MEMO	Max/min power failure protection. Y: open, N: Close	0 (N) 1 (Y)	N
29	SQRT	linear signal Square root	0 (N) 1 (Y)	N
30	STEP	Display jumping interval	1~10	1
31	BRL	Analog output low limit	FL~FH	FL
32	BRH	Analog output high limit	FL~FH	FH
33	OLL	Adjust analog output low limit OLL=(preset analog low limit - actual analog low limit)/ actual analog range*1000	-500~1000	0
34	OLH	Adjust analog output high limit adjustment OLH=(preset analog high limited - actual analog high limit)/ actual analog range *1000+1000	0~1050	1000
35	BAUD	Communication baud rate	4.8K, 9.6K, 19.2K	9.6K
36	ADDR	Meter communication address	1~255	1
37	PRTY	PRTY Communication parity check 0: (NO) No check 1: (ODD) Odd check 2: (EVEN) Even check	NO, ODD, EVEN	NO
38	DTC	Communication delay time	Refer remarks (page 14)	0
39	AE1	AL1 extensions	0~11	0
40	AE2	AL2 extensions	0~11	0
41	AE3	AL3 extensions	0~11	0
42	DL1A	AL1 start delay (unit: s)	0~999.9	0.0
43	DL1B	AL1 close delay (unit: s)	0~999.9	0.0
44	DL2A	AL2 start delay (unit: s)	0~999.9	0.0
45	DL2B	AL2 close delay (unit: s)	0~999.9	0.0

46	DL3A	AL3 start delay(units)	0~999.9	0.0
47	DL3B	AL3 close delay(units)	0~999.9	0.0
48	CJC	Thermocouple cold end compensation method, auto-compensation, close compensation, manual compensation	-1 (Auto), 0 (Off), 1~50	Auto
49	RLMR	linear resistance value, useable when linear resistance is high (Unit: mΩ)	0~9999	0
50	TEST	Analog input test, used to test output function	FL~FH	OFF
51	CAE	Enable user's self-calibration, this parameter is for linear signal only; Y: use the parameter self-calibrated by user; N: don't use the parameter self-calibrated by user	0 (N), 1 (Y)	N
52	CAL	User set the low-limit input by themselves; after input the low-limit signal, flash display YES, press "CAL" to confirm, when it display OK, the input signal low-limit is set.	YES/OK	YES
53	CAH	User set the high-limit input by themselves; after input the high-limit signal, flash display YES, press "CAL" to confirm, when it display OK, the input signal high-limit is set.	YES/OK	YES
54	VER	Software version	Unable to set	V1.0

1. High/low point display setting function
 Example: use electronic ruler or others to measure distance, if want position 5mm display 500, position 6mm display 600, firstly enter function shielding menu to set SF1= Y (open CAS, CAK parameter), then while the position is at 5mm, enter the menu to set CAS=500; while the position is at 6mm, enter the menu to set CAS=600. After exit the menu, it will corresponding indicate 500~600 between 5mm and 6mm.

2. Linear signal self-calibration function
 a) Set INP type, and make sure it is one of the linear signal.
 b) The input signal should be applied to the correct input channel.
 c) Enter low limit calibration menu CAL, press "CAL" to flash "YES"; after adjusting the input signal to the minimum value, then input it to the meter.
 d) When "YES" flashing, and the minimum value of input signal has been inputted into the meter; press "CAL" to confirm and save calibration value.
 e) After the low limit is calibrated, enter high limit calibration menu CAH, and flash "YES" in the same way.
 f) Adjust the input signal to the maximum value, and input it into the meter. And when "YES" flashing, press "CAL" to confirm and save calibration value of high limit.
 g) After calibration, enter CAE to change "N" into "Y" to enable self-calibration; otherwise, it will use the default calibration value.
 h) The calibrated high limit input value of linear signal should not fall outside the input standard range ±10%.
 i) After the calibration, if the result is not satisfactory, it can be recalibrated.

3. Analog range calibration function
 Example: actual high limit is 20.4mA, low limit is 3.97mA. To calibrate the analog range through the modification of OLL, OLH.
 $OLL = (\text{Preset analog low limit} - \text{actual analog low limit}) / \text{actual analog range} * 1000 = (4.0 - 3.97) / (20.4 - 3.97) * 1000 = 2$
 $OLH = (\text{Preset analog high limit} - \text{actual analog high limit}) / \text{actual analog range} * 1000 + 1000 = (20.0 - 20.4) / (20.4 - 3.97) * 1000 + 1000 = 976$

VIII. Alarm parameters and output logic diagram

Alarm code	Type	Logic diagram
L	Absolute value low limit alarm	
H	Absolute value high limit alarm	
HL	Interval alarm	
DL	Deviation alarm	

8

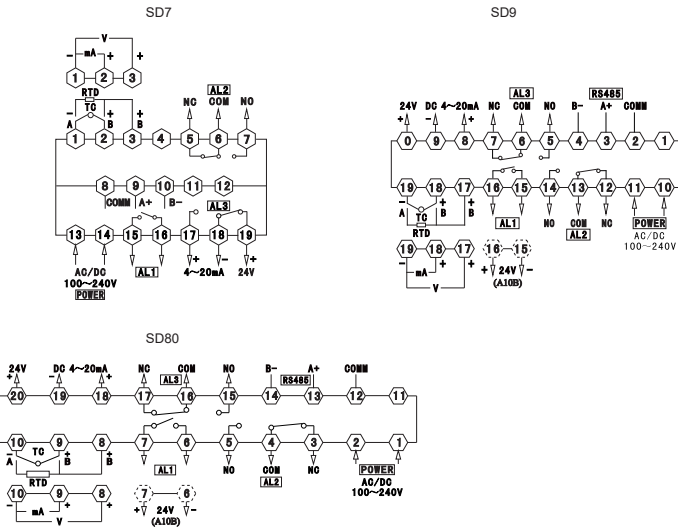

Note: If there is any change, please subject to the drawing on the meter

XI. Exclusive methods of simple fault

Display	Methods
HHHH/LLLL	Checks whether the input signal connects or not, whether the figure of FH/FL value is too small, whether input signal is selected correctly, whether working environment is normal.

XII. Communication protocol

Meter adopt Modbus RTU communication protocol, RS485 half duplex communication. Read function code: 0x03, write function code 0x06 or 0x10. Adopts 16 digit CRC check, the meter does not return for error check.

Data frame format:

Start bit	Data bit	Stop bit	Check bit
1	8	1	No

Abnormal communication processing:

When abnormal response, put 1 on the highest bit of function code. For example: when host request function code is 0x03, slave response function code should be 0x83.

Error code:

0x02---Illegal address: the register address designated by host beyond the address range of meter.

Communication cycle:

Communication cycle is the time from host request to slave response data. ie: communication cycle= time of request data sending + slave preparation time + response delay time + response return time.

Eg: 9600 Baud rate: communication cycle of single measured data ≥ 250ms.

Alarm extension function table

AE1/AE2/AE3 value	Alarm mode when show over limit	Whether restrain alarm when power on	Alarm control fineness
0	State invariant	Do not inhibit	Alarm control with highest resolution of the meter
1	Forced alarm output	(As long as it meets the requirement of alarm, alarm output)	
2	Forced alarm close		
3	State invariant	Inhibit	Alarm control with display resolution
4	Forced alarm output	(Forced alarm close when power on; alarm does not output until the alarm condition from noncoincidence to coincidence.)	
5	Forced alarm close		
6	State invariant	Do not inhibit	
7	Forced alarm output	(As long as it meets the requirement of alarm, alarm output)	
8	Forced alarm close		
9	State invariant	Inhibit	
10	Forced alarm output	(Forced alarm close when power on; alarm does not output until the alarm condition from noncoincidence to coincidence.)	
11	Forced alarm close		

IX. Dimension

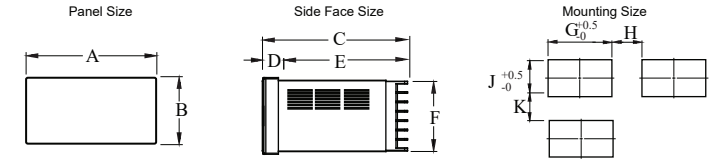

No.	A	B	C	D	E	F	G	H(Min)	J	K(Min)
4:(48*48)	48	48	97.5	6.5	91	45	45.5	25	45.5	25
6:(96*48)	48	96	97.5	9	88.5	89.5	45	25	92	25
7:(72*72)	72	72	97.5	9	88.5	67	67.5	25	67.5	25
8:(48*96)	96	48	97.5	9	88.5	44.5	92	25	45	25
9:(96*96)	96	96	97.5	9	88.5	91.5	92	25	92	25
80:(80*160)	160	80	96	13	83	75.5	155.5	30	76	30
16:(160*80)	80	160	96	13	83	155	76	30	155.5	30

X. Connection drawing

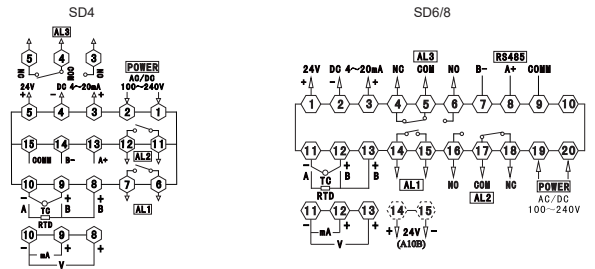

9

1 Read register (0x03)

For example: Host reads integer AL1 (AL1=200)

The address code of AL1 is 0x3201, because AL1 is integer (2 byte), seizes 1 data register. The memory code of decimal integer 200 is 0x00C8.

Note: It should read DP value or confirm DP menu value first to ensure the decimal point position when reading data, and converse the reading data to get the actual value. On the contrary, it should converse the data to corresponding ratio first before writing the data into meter.

Host request (Read multi-register)							
1	2	3	4	5	6	7	8
Meter ADD	Function code	Start ADD High bit	Start ADD Low bit	Data byte length high bit	Data byte length low bit	CRC code low bit	CRC code high bit
0x01	0x03	0x32	0x01	0x00	0x01	0xDB	0x72

Slave normal answer (Read multi-register)						
1	2	3	4	5	6	7
Meter ADD	Function code	Data byte number	Data high bit	Data low bit	CRC code low bit	CRC code high bit
0x01	0x03	0x02	0x00	0xC8	0xB9	0xD2

Address error abnormal answer: (For example, host request address is 0x2101)

Slave error answer				
1	2	3	4	5
Meter ADD	Function code	Error code	CRC code low bit	CRC code high bit
0x01	0x83	0x02	0xC0	0xF1

2 Write multi-register (0x06)

For example: Host writes AL1 (First alarm set value 100)

The address code of AL1 is 0x3201, because AL1 is integer (2 byte), seizes 1 data register. The hexadecimal memory code for decimal integer 100 is 0x0064.

Host request (Write single-register)							
1	2	3	4	5	6	7	8
Meter ADD	Function code	Data ADD High bit	Data ADD Low bit	Data High bit	Data Low bit	CRC code low bit	CRC code high bit
0x01	0x06	0x32	0x01	0x00	0x64	0xD7	0x59

Slave normal answer (Write single-register)							
1	2	3	4	5	6	7	8
Meter ADD	Function code	Data ADD High bit	Data ADD Low bit	Data High bit	Data Low bit	CRC code low bit	CRC code high bit
0x01	0x06	0x32	0x01	0x00	0x64	0xD7	0x59

